

22W/8851T00

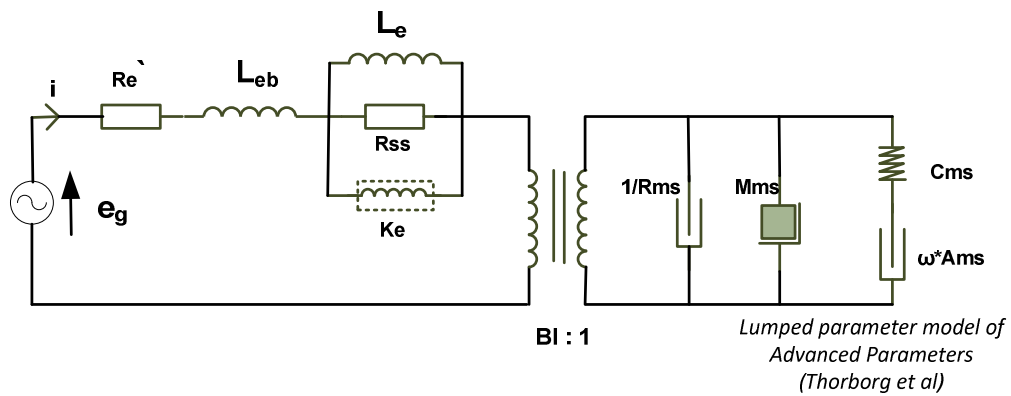

Electrical data

DC resistance ($R_{e'}$)	6.38	[Ω]
Free inductance (L_{eb})	0.175	[mH]
Bound inductance (L_e)	12.52	[mH]
Semi inductance (K_e)	0.025	SH
Shunt resistance (R_{ss})	564	[Ω]

Mechanical data

Force factor (BI)	9.20	[Tm]
Moving mass (M_{ms})	34.0	[g]
Compliance (C_{ms})	1.74	[mm/N]
Admittance (A_{ms})	0.31	[mm/N]
Mechanical resistance (R_{ms})	0.92	[Ns/m]